



TECHNOLOGY  
SUBJECTS  
SUPPORT  
SERVICE

Leaving Certificate

# Technology

## Control Technology

PICAXE18X



# *Contents*

Prog. 1.....	SOUND Output
Prog. 3 .....	OUTPUT & WAIT
Prog. 6 .....	LOOP
Prog. 7 .....	Seven Segment Display
Prog. 8 .....	Single Traffic Light Sequence
Prog. 9 .....	Double Traffic Light Sequence
Prog. 10 .....	Decision / Digital Input
Prog. 11 .....	Motor / Buzzer Control
Prog. 12 .....	Forward / Reverse Motor Control
Prog. 13 .....	AND gate
Prog. 14 .....	OR gate
Prog. 15 .....	NAND gate
Prog. 16 .....	OUT
Prog. 17 .....	PROCEDURE
Prog. 19 .....	EXPRESS & INC
Prog. 20 .....	COMPARE
Prog. 21 .....	Exercise
Prog. 22 .....	RANDOM number
Prog. 23 .....	INTERRUPT
Prog. 24 .....	Analogue Sensors - LDR
Prog. 25 .....	Variable Resistor
Prog. 26 .....	Temperature

Before using this package ensure that you have selected the correct software. The following courseware assumes the use of PIC Logicator 2006. Go to PIC, select PIC type, and choose the PICAXE18X. This is the preferred PIC device and having 5 inputs and 8 outputs can be used for a wide array of classroom based projects.

## PROG.1 – 'SOUND' command

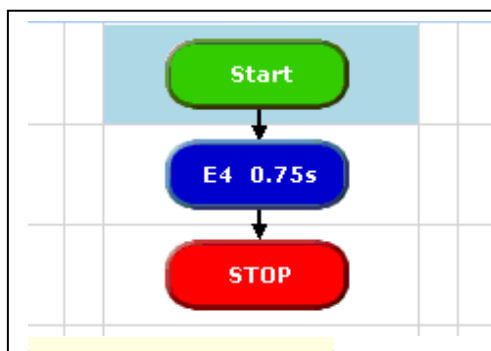

Drag each command from the right hand side of your screen. Click and hold down the left mouse button to drag in each command. The second cell makes use of the sound command. Double click the left button on the sound command. This will open a window and allow you to select a sound value. Scroll or

type to enter the selected value, set pin 3 as output and set the note to E4. You can set the duration of the note by placing a value in the time box i.e. 0.75s.

Select the drawing tool icon, this shows as a pencil, right click where you want the line to begin; then right click where you want the line to end. Click the green arrow to RUN and test.

## PROG.2

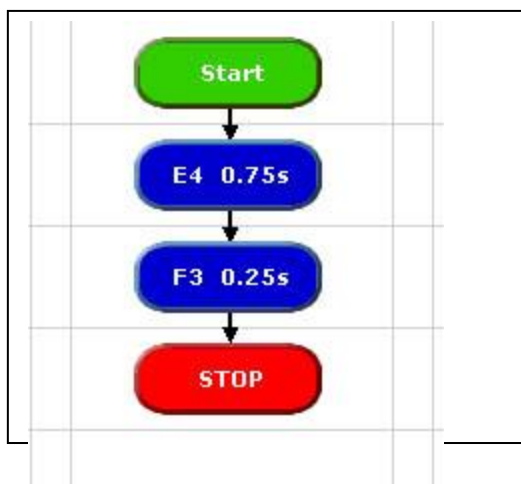

Double click the left button on sound cell.

This will open a window and allow you to select a sound value. Scroll to enter the selected value. Set the output pin to 3. Set the duration by selecting a time value. Repeat for the second sound value – F3, 0.25s.

Join the cells using the drawing tool as before.

Test and run your programme.

PROG.3 – ‘OUTPUT’ & ‘WAIT’ command

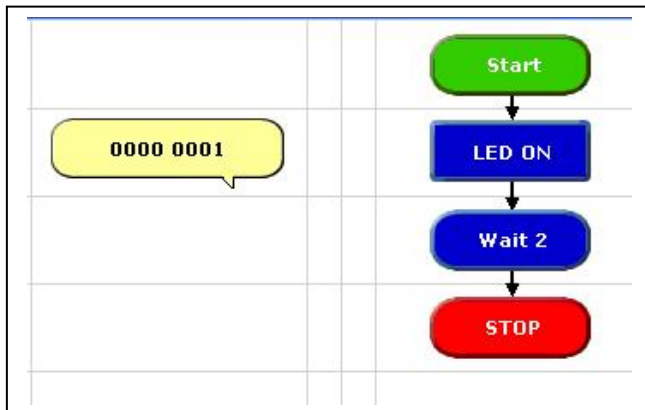

Outputs are used to turn LEDs, light bulbs or other outputs on and off. Note that the PIC cannot switch bulbs directly but must use a driver circuit (in most cases – a transistor)

WAIT is used to set the length of time the lamp / LED is turned on. WAIT is set using seconds or fractions of a second e.g. 2 seconds in this case.

‘LED ON’ is called a label. Note however it is the setting on the output line using the bit pattern 0000 0001 which causes the LED to turn on – NOT the label.

PROG.4

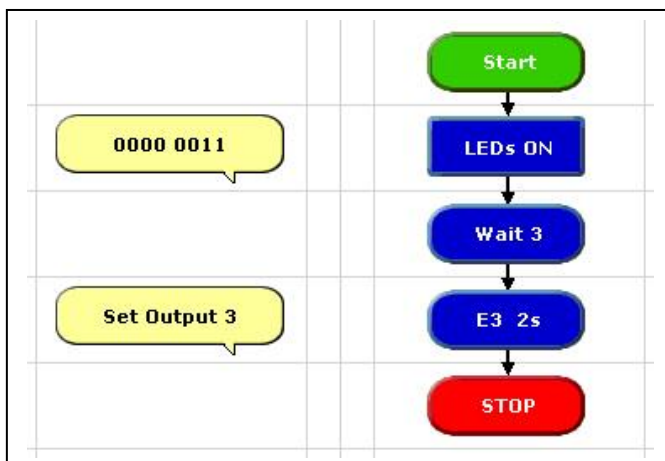

It is possible to turn on a number of outputs at the same time by setting the correct ‘bits’. Each bit controls one output. In this case two LEDs are driven from output 0 and output 1. The yellow comment boxes are useful as they allow us to see how the outputs are set.

Note that in the cell LEDs ON both LEDs will light. The WAIT command instructs that the LEDs should remain on for 3 seconds. The program then moves to the SOUND cell. The LEDs do not turn off at this point but remain on. If we wish the LEDs to be turned off then we must instruct them to be turned off by setting the outputs to 0000 0000. In this case the STOP command turns off all outputs.

## The 'OUTPUT' command – Bit Configuration

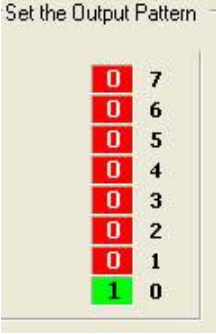
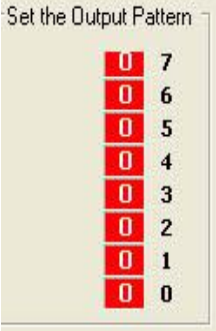
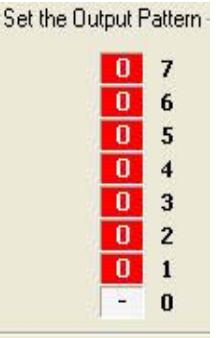
	<p>There are three settings that can be used when setting Outputs.</p> <p>(a) Let us look at Bit 0 – in this case it has been set to 1 or ON.</p>
	<p>(b) Bit 0 has now been set to 0 which means that the output is switched OFF.</p>
	<p>(c) There is a third state to which BIT 0 can be set. This is represented by a dash as shown below. Care must be taken if you choose to use this option. The dash is used as a 'doesn't matter' state. This means that the output will not change from where it was set previously. If it was on then it will remain on and if it were off then it remains off. This can lead to confusion – set all bits to either 1 or 0.</p>

PROG.5

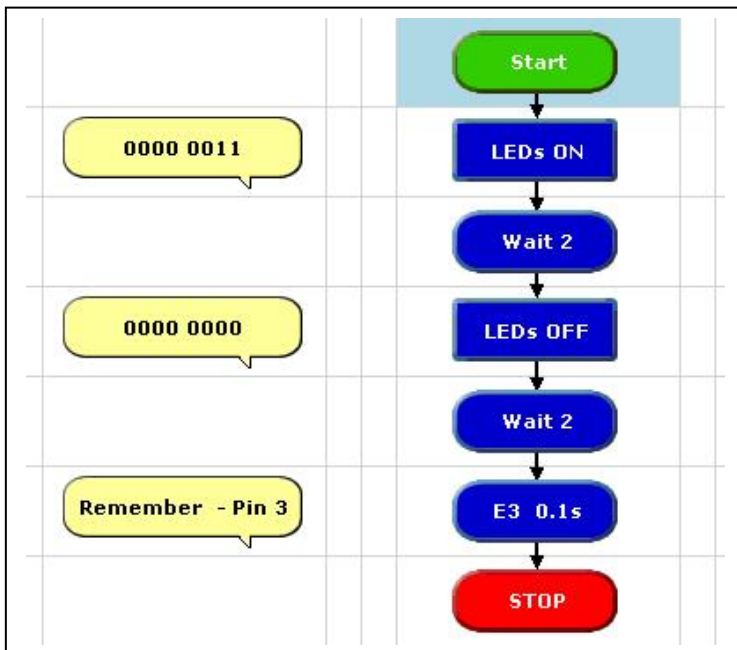

This program turns on two outputs to which LEDs are connected. Can you follow the sequence through?

*Remember we must tell the program which pin is connected to the piezo sounder i.e. pin 3, as this pin is pulsed on and off and not simply switched on as is the case in an LED.*

PROG. 6 – ‘LOOP’ command

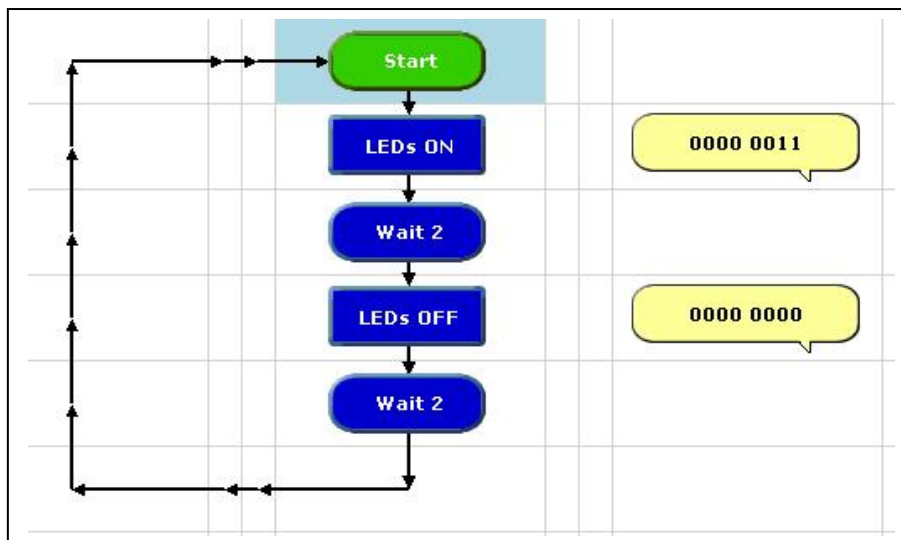

The program shown will cause both LEDs to flash on and off forever. This is achieved by using the loop back to the start of the program. This is really useful as many procedures in real life run continually. These

include automated drilling of PCB boards or traffic light sequences which run forever. The advantages of using the PIC should start becoming obvious. If we need to change the sequence or part of the sequence (e.g. change the wait to 1 second) we simply rewrite the software, not remake the circuit.

## PROG.7 - Seven Segment Display

It is possible to control a seven segment display using your control board. Each segment of the display is in fact an LED. What we must do therefore is work out which LED is controlled by which bit. Note that the bits are numbered 0-7 and this can sometimes lead to confusion.

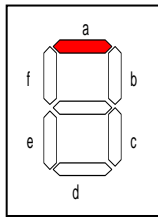

Controlled by bit \_\_\_\_\_

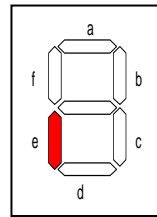

Controlled by bit \_\_\_\_\_

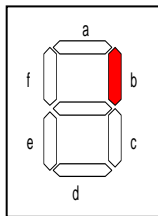

Controlled by bit \_\_\_\_\_

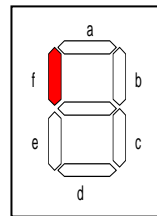

Controlled by bit \_\_\_\_\_

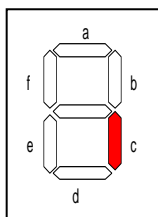

Controlled by bit \_\_\_\_\_

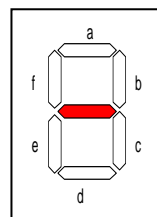

Controlled by bit \_\_\_\_\_

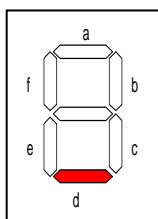

Controlled by bit \_\_\_\_\_

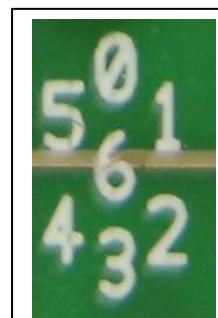

The image opposite, found on your control board, should prove really useful!! Can you see that output 0 controls the 'a' etc.

Now that we know which segment is controlled by each bit it is possible to design a program that will allow us to count from 0 to 9. If we include a 1 second delay in the program it is possible to make a stopwatch. In the case of connecting to the PIC note that we can control each segment of the LED directly, as it only requires 5-10mA. When ordering, ensure the 7 segment display is the common cathode type.



**PROG.8 – Single Traffic Light Sequence**

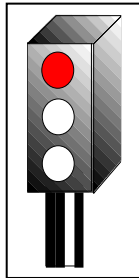

Step – 1

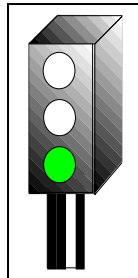

Step - 2

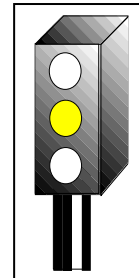

Step - 3

Shown above is the sequence of lights on a single traffic light. Write a program that will follow this sequence and repeat forever.

Step – 1 (Bit pattern)    \_ \_ \_ \_ \_  
 Step – 2 (Bit pattern)    \_ \_ \_ \_ \_  
 Step – 3 (Bit pattern)    \_ \_ \_ \_ \_

**PROG.9 – Double Traffic Light Sequence**

In the case of road works however there are two sets of traffic lights. Follow the sequence and program the double set of lights.

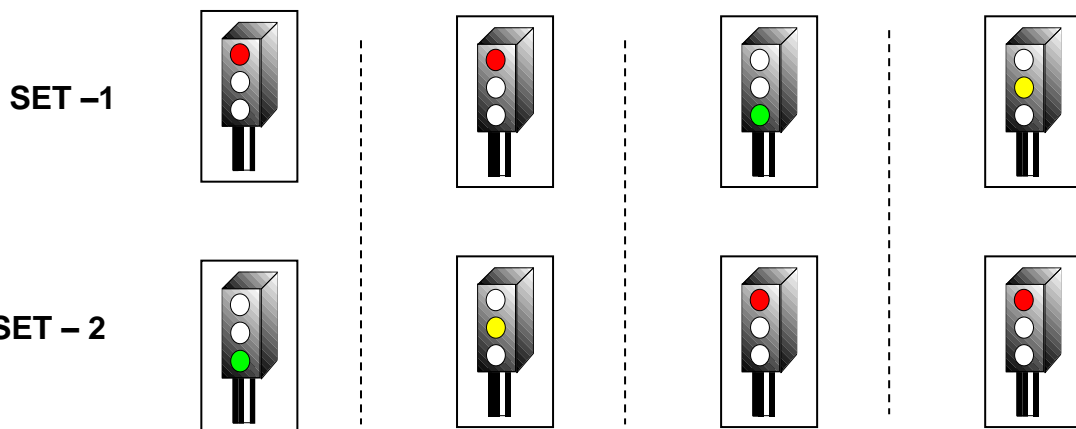

(Bit Pattern)    \_ \_ \_ \_ \_

## PROG.10 – ‘DECISION’ command

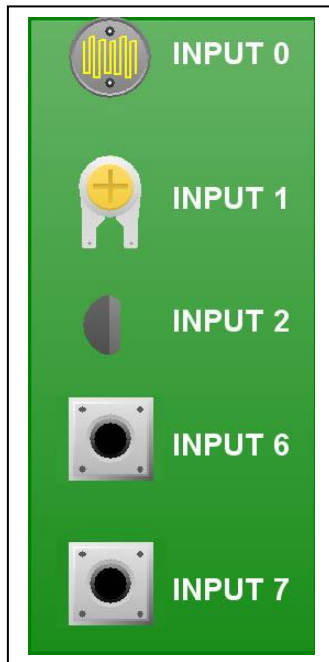

In real life as well as processes which run continually there are times when user input is necessary. Nowadays however there is a tendency to automate the process in response to changes in light, temperature, liquid level or other stimuli. So far we have used the PIC to drive outputs such as LEDs and Piezo sounders. The real value of control technology is when outputs are driven or controlled by the input conditions.

On your control board, five inputs are included. The inputs are labelled as shown, the reason for this will be covered later. Let us begin by redesigning a previous program to include a switch (Input 7) used as an input.

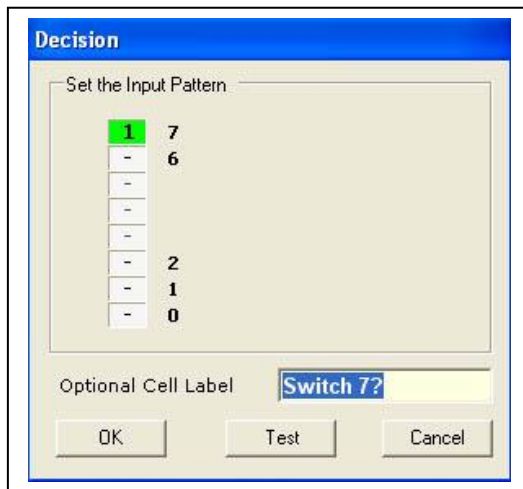

How do I set an input? Well this is quite easy really, once you begin to understand decisions boxes. By dragging in a decision box and clicking on it, the window opposite opens. You can see there are only five inputs available and that the numbers correspond with the diagram above. One thing you must understand is that when switch seven has **not** been

pressed the voltage at input 7 is 0V or low. In digital terms we say that when not pressed Input 7 is a zero (0). When the switch is pressed, input 7 goes to 5 volts or high. We say it is now a one (1). The dashes mean we are ignoring the other inputs, looking only at Input 7. By using this syntax we are really asking a question and as a result making a decision. Has the switch which is connected to input 7 been pressed? If the answer is yes carry out this instruction, if not do this. Please note that it is **not the label** which determines the decision but rather which inputs are set to 1 or 0.

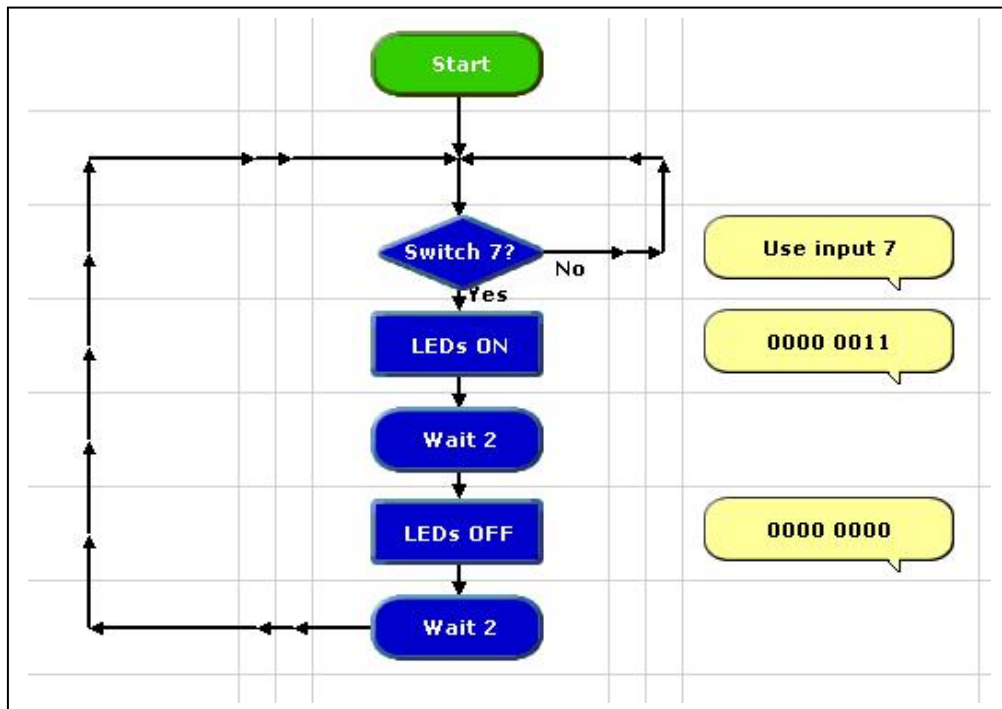

Please ensure that you use a decision box and not a compare box which performs a different function. Remember to set input 7 to a 1 or high as shown previous. When you start the program nothing happens until the switch (Input 7) is pressed. When the switch is not pressed the decision box will continually 'ask' has the switch been pressed and on finding the answer is No it will follow this route out of the decision box and back in again.

On the other hand when the switch has been pressed and Input 7 is in fact 1 then the answer to the question is now positive and the Yes route is followed. This means that the LEDs will be turned on for two seconds and so on.

Note that when completed the program returns to the decision box awaiting the next press of the switch.

**Please note.**  
 Understanding the operation of a decision box is vital to maximizing the use of control technology. Do not progress until you have a full understanding of the previous program.

## PROG.11 – Motor / Buzzer Control

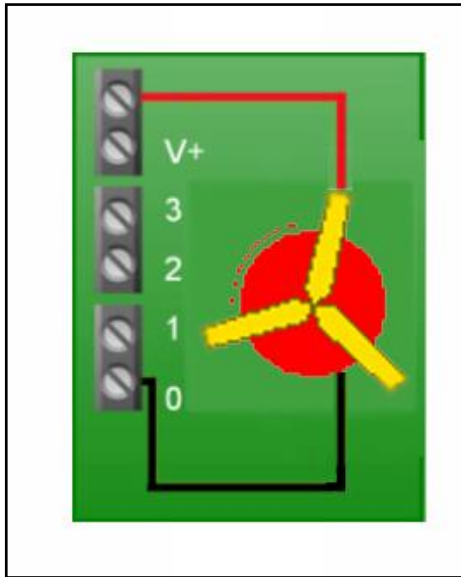

To control a motor or buzzer we connect either component in the position shown. These terminals blocks are found to the right hand edge of the control board. One end of the motor or buzzer must be connected to the positive supply, V+, and the other to one of the outputs 0, 1, 2 or 3.

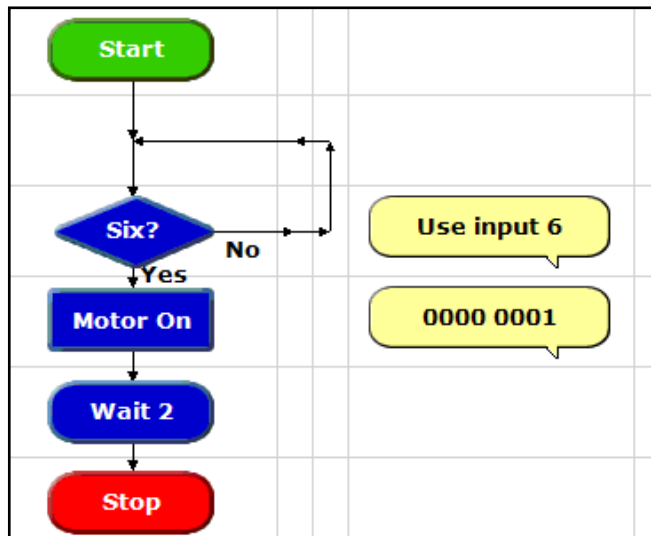

The program opposite shows how we are using input 6 which is a tactile switch. Again when not pressed the input is 0 but 1 when pressed. Input 6 therefore is set to look for a 1 when pressed.

Two further points to note:

The label used this time is 'Six?' Remember the label is irrelevant, rather if the inputs are set to check for 0 or 1.

Secondly note that the program does not loop to the start again but only runs once. Note also that we did not turn off the motor as this happens automatically when the stop command is reached.

PROG. 12 – Forward and Reverse Motor Control



There are two main methods of controlling motors. One method uses the L293D and we also use a double set of relays. Note however that the L293D can only carry around 600mA of current and many motors have a much higher requirement than this. One of the ICs on the board is an L293D and we can connect two motors into positions C and D.



The screenshot shows a software interface for motor control. On the left is a 'Motor' dialog box with a slider for 'Motor D' set to the right, and 'Motor C', 'Motor B', and 'Motor A' sliders set to the left. A 'Stop' button is visible. On the right is a flowchart with a green 'Start' button, a blue 'MOTOR D' button, a blue 'Wait 3' button, and a red 'STOP' button.

To control a motor using the on-board L293D, drag a motor control box in from the command list. Click to open and you are presented with a number of options. Since we only have two motors in positions D and C we can therefore ignore Motors A

and B. With a motor attached to the terminal block labeled D we simply move the slider control to the right to rotate the motor in one direction and to the left to rotate the motor in the opposite direction.

To stop the motor the slider should be placed in the mid position.

## PROG.13 – ‘AND’ gate

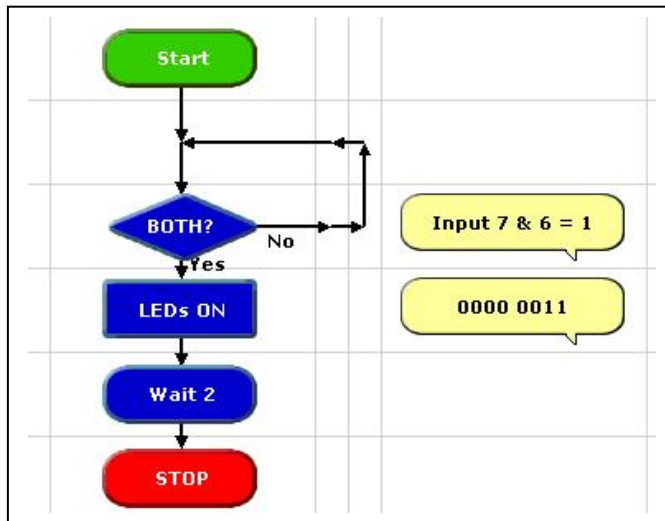

By setting both inputs 7 and 6 to 1 means the yes route will only be followed when both switches are pressed simultaneously.

Write and run the following program and see if you can figure out how it works. Are there any applications which could make use of this operation? Think of machines commonly

found in your own classrooms.

The program above is in fact an AND gate application.

INPUT A	INPUT B
---------	---------

0	0	0
0	1	0
1	0	0
1	1	1

From the above truth table we can see that in order to have an output both switches must be pressed.

PROG.14 – ‘OR’ gate

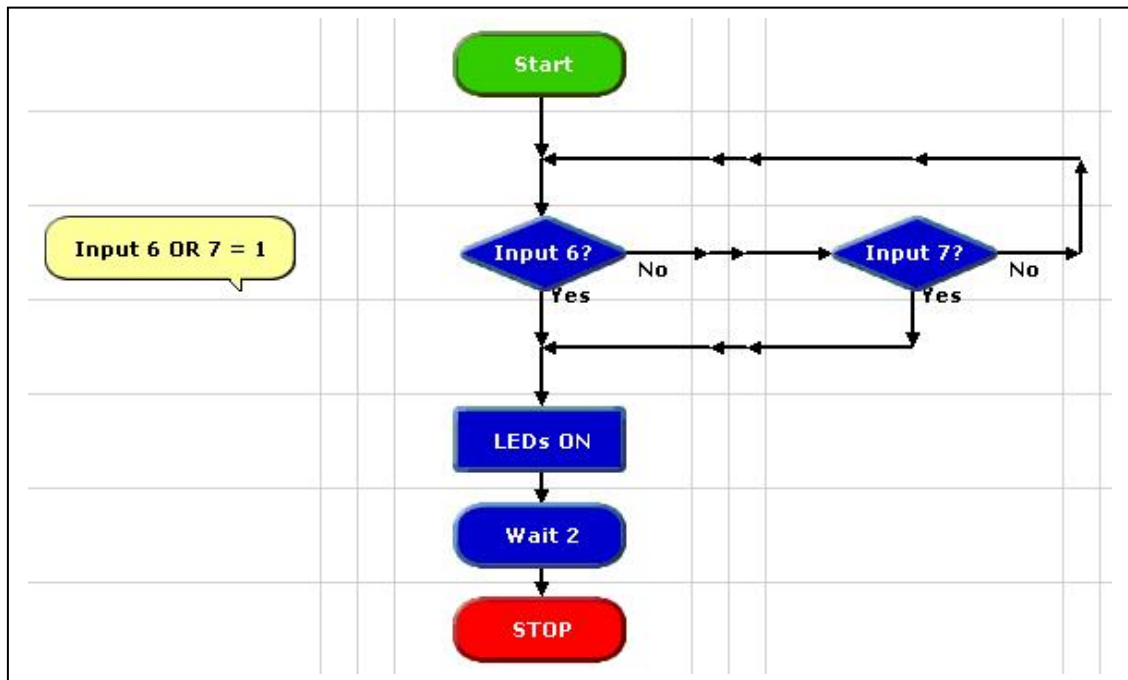

By building and running the program shown confirm that this behaves as an OR gate. Complete the truth table below. Note that Input 6 is set to a 1 in the first decision box and that input 7 is set in the second. Write a paragraph to explain how this program operates.

INPUT A	INPUT B
---------	---------

0	0	0
0	1	

## PROG.15 – NAND gate

Making good progress? Great, because this one is just a bit more difficult. Design a program to simulate two switches connected to an NAND gate. Remember to use inputs 7 and 6 as before. The truth table is shown below. Check your answer by going through each line of the table. The solution is given at the end of these notes, don't even think about it!!

INPUT A	INPUT B
---------	---------

0	0	1
0	1	1
1	0	1
1	1	0

## PROG.16 – 'OUT' command

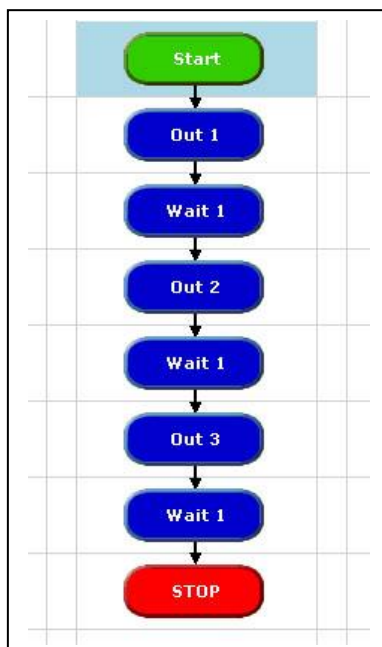

The OUT command can also be used to control outputs. It has certain advantages in that a number of outputs can be controlled simultaneously. Follow the binary pattern below and we begin to make sense of how this command works. OUT 1 will switch on the first output and OUT 2 the second and so on. What will OUT 3 do? Well, 3 is 2&1 so we switch on the first two LEDs. Try the following OUT 56, OUT 128, OUT 136 and OUT 220. Can you predict which LEDs will light *before* setting the OUT command?

- |     |    |    |    |   |   |   |   |
|-----|----|----|----|---|---|---|---|
| 128 | 64 | 32 | 16 | 8 | 4 | 2 | 1 |
|-----|----|----|----|---|---|---|---|



**PROG.17 – ‘PROCEDURE’ command**

Procedures are very useful to use in our programs. They are used when there is a block of code or instructions that are used repeatedly in our program. The following program shows how the procedure ‘FLASH’ is called five times in the same program. We use the ‘Do Proc’ command to call a macro and the ‘Procedure’ command to define what it is we wish to do. Note these are two distinct commands, do not mix them up.

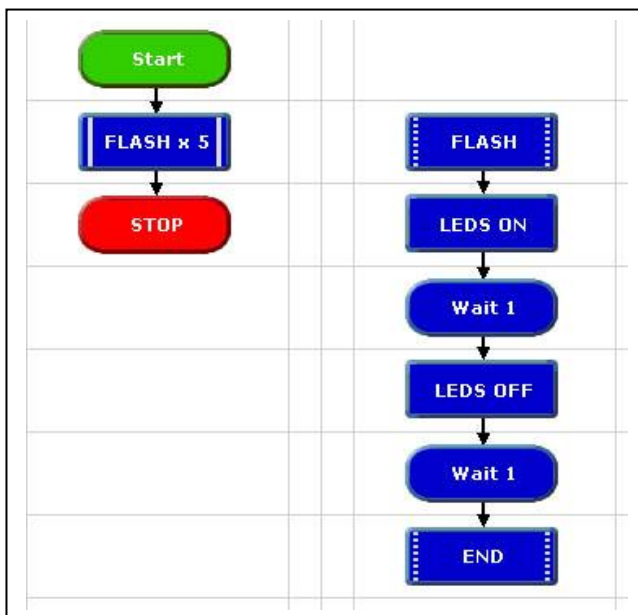

Not only does using the procedure make the program five lines shorter, as the commands to make the LEDs flash on and off are only inserted once, but the program is much neater and easier to follow. Use macros in your program where possible.

**PROG.18**

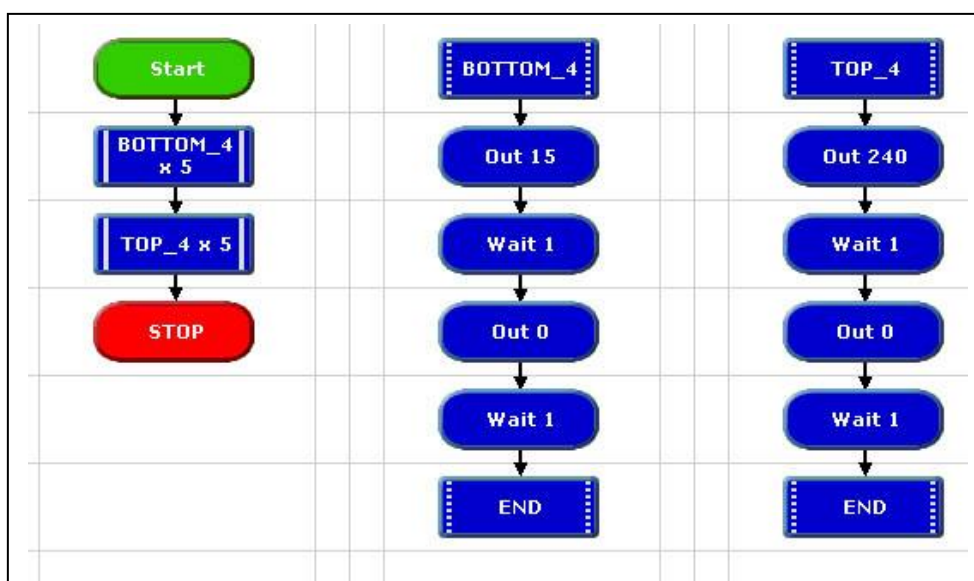

This is a good example of using procedures to reduce the size of a program. Run this program and understand how it works.

## PROG.19 – ‘EXPRESS’ & ‘INC’ command

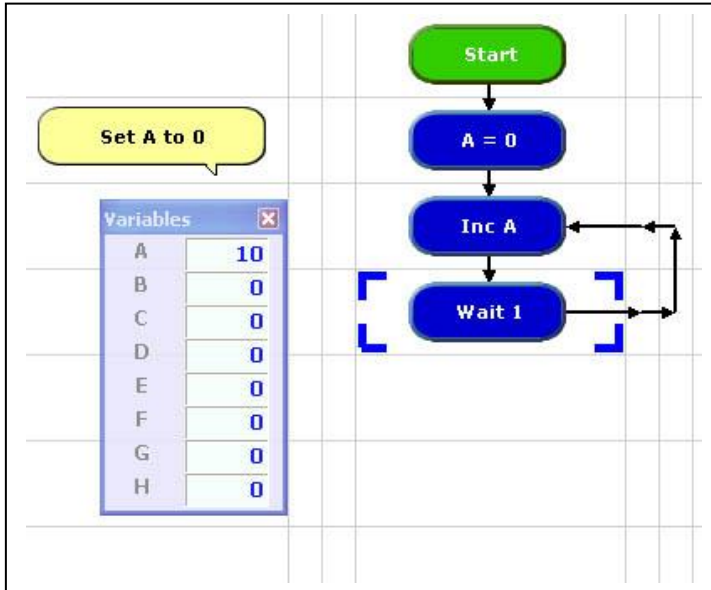

This program introduces variables and the INC or increment command.

Variables are very useful and are used just as in maths, to store numbers or values. The variable we are using is called ‘A’. Using an expression box we set A = 0 at the start. This is always good practice. INC is a command found on the

command list, and we set it to INC variable A. This means that A should increase in value by 1 every second as we have created a loop with a Wait and INC command. Before running this program, go to View and select the Variables Panel. As the program runs we should see the value of A increase by 1 every second.

## PROG.20 – ‘COMPARE’ command

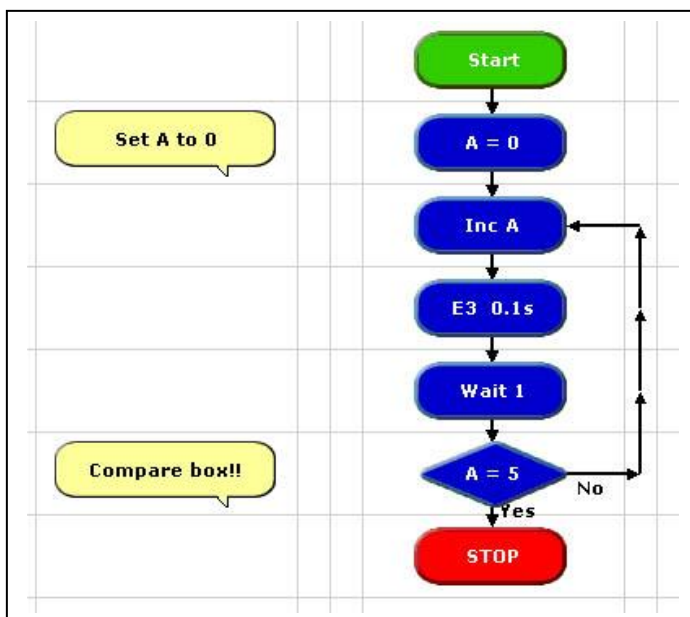

It is sometimes useful to be able to make a process happen a fixed number of times. A continuous loop will not allow us to do this, as the operation will be repeated again and again. Follow this program and observe that the sound can be heard five times.

Note that we do not use a decision box on this occasion but rather the compare command.

## PROG.21 – Exercise



**'Mars' chocolate bar company has decided to release a new family pack containing seven bars.**

**Your task is to design a system which will recognise when seven bars have passed along the conveyor belt and switch on a motor (Output 1) which will push the seven bars into their packet. Alert the user that seven bars have been packaged.**

**Break the project into a number of smaller tasks.**

- **How will we know when a bar has gone past? (Micro-switch?)**
  
- **How can we count seven bars? ('INC' command)**
  
- **When seven bars have been counted, switch on a Motor and a Sound to warn the user.**

## PROG.22 – 'RANDOM' number

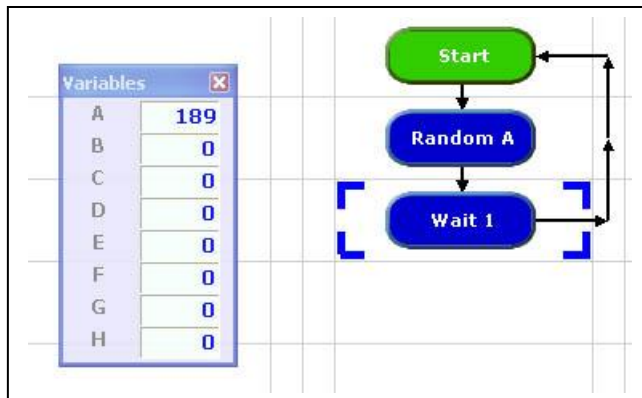

Random will generate a random number from 0 – 255. By using the variables panel we are able to see that a random number is generated each second.

Random will generate any random number from 0 - 255

PROG.23 – ‘INTERRUPT’ command

Consider the case of a lathe or similar machine. All should be fitted with a switch that will not allow the machine to be restarted until a safety guard is in place. As soon as the guard is lifted the machine will stop immediately. We have no way of knowing when the guard might be lifted – this is probably one of the best ways of describing what happens in the case of an interrupt.

In this case the following program it will turn on a motor and allow the motor to run until the interrupt has been triggered by pressing the switch (Input 7). The event is usually triggered by a switch being pressed or released. The program will return to the wait command when the interrupt commands have been completed.

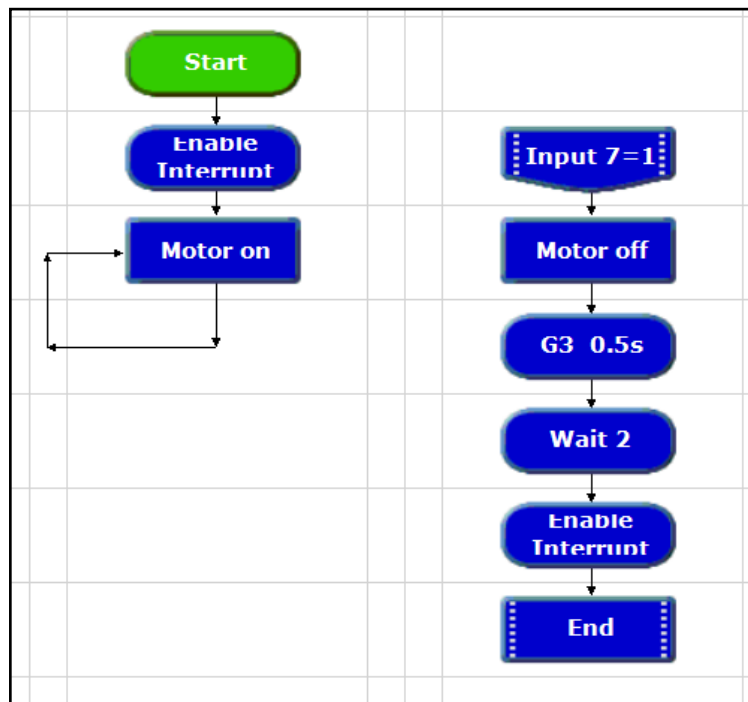

The difference between an interrupt and an ordinary decision box is that the interrupt tests for the condition all the time. In the case of the decision box the switch is only tested when the program reaches that part of the program.

- Each time an interrupt is called the Enable Interrupt command is switched off, the first thing you should do before when you re-enter the main program is to turn the event on again.
- In the case of the PICAXE18x only one interrupt can be used within a program.

## PROG.24 – Analogue Sensors

Temperature and light are examples of analogue conditions. We have three on-board analogue sensors:

LDR – Input 0

Potentiometer – Input 1

Digital thermometer – Input 2

Let us begin by considering the LDR. Assume we wish to turn on a security light if the light intensity drops below a particular level.

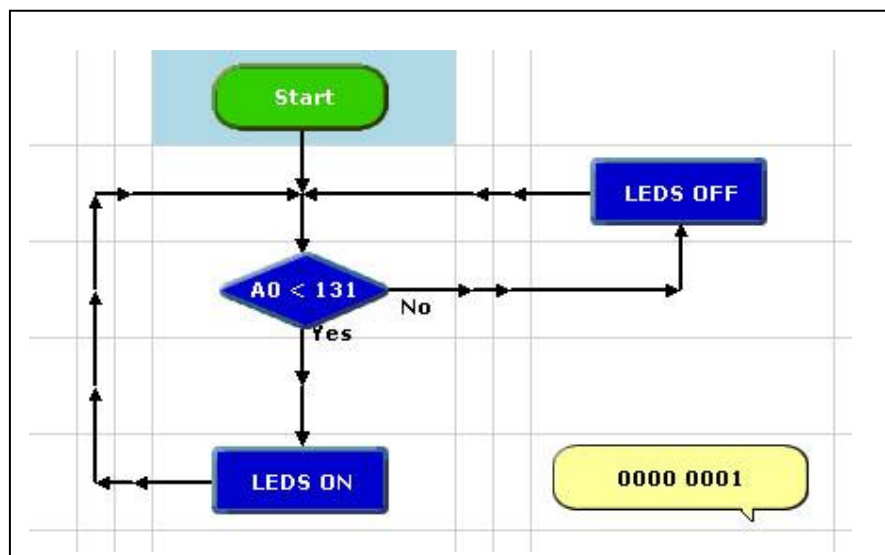

The PIC uses a process called analogue to digital conversion (ADC). This means that the input voltage can range from approximately 0 to 5 volt depending on the light levels. The PIC reads this voltage and converts it to a number between 0 and 255. When the voltage is close to 0V then the readout is 0 but when close to 5V we obtain a reading of 255. A reading of 2.5V gives a conversion of 128.

In the program above a compare command is used to determine if the light level is less than 131, this is an arbitrary value. If the light level is greater then the LEDES OFF output box ensures that all the outputs are switched off. If the reading is less than 131 then the LEDs are switched on.

PROG.25 – Variable Resistor

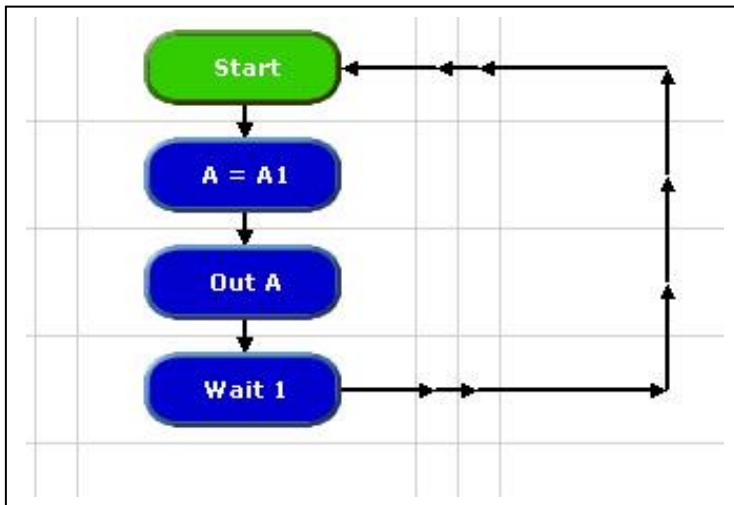

A variable resistor is connected to input 1. The value of the resistance is used to switch on a number of LEDs depending on which position the variable has been adjusted to. Slowly rotate the variable in each direction and note the reading. Can you see

an application for measuring the amount of oil in a tank at the bottom of the garden? Hint: Think of a cistern!

There is a second method of checking the position of the variable resistor.

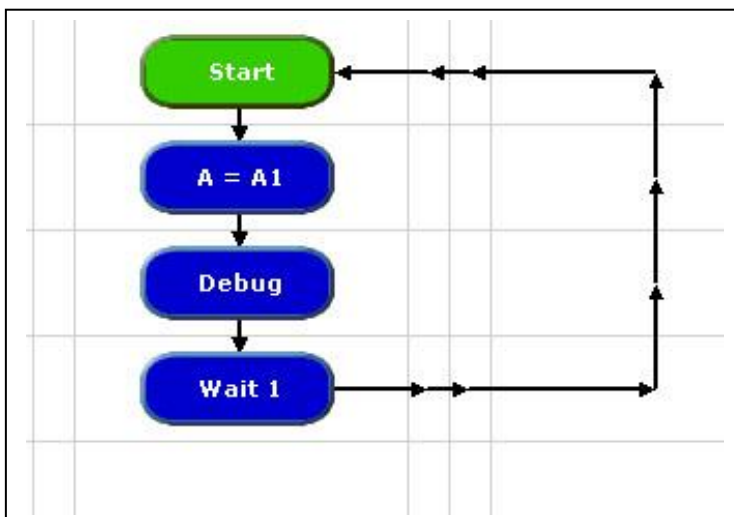

This program makes use of the 'Serial in' – pin 3. Essentially, debug causes a message to be transmitted from the PIC back to the computer screen. This shows up as a value in the pop-up window. Both programs should produce the same

result. To display the pop-up window go to PIC on the main menu and select 'DEBUG...' or use Alt + F7.

## PROG.26 – Temperature

This program demonstrates the potential for making use of the digital thermometer which is connected to input 2. Using the ReadTemp we set the variable A as being equal to the readout from the thermometer. Note that in this case we do not obtain a reading of between 0 and 255 but rather a reading of

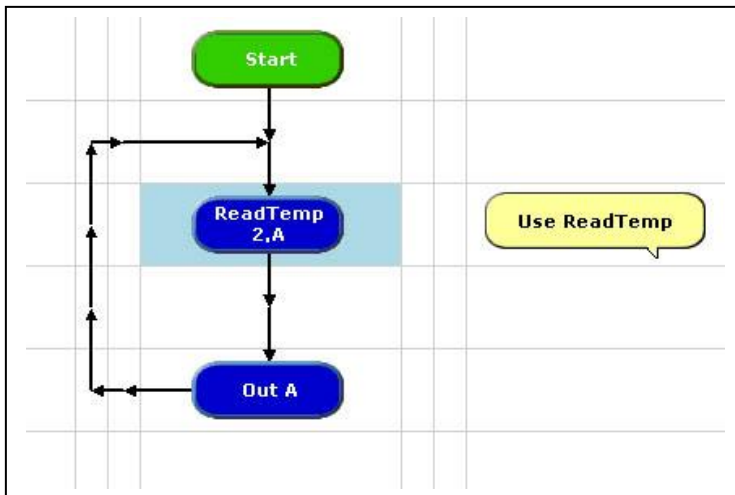

between 10 and 40 degrees depending on the temperature of the surroundings.

We then use the OUT command to cause a number of LEDs to light. Assume the room temperature is 17° then an OUT A would result in the first and fifth LEDs being lit. Using the binary scale below

can you understand why it is these two LEDs which are switched on.

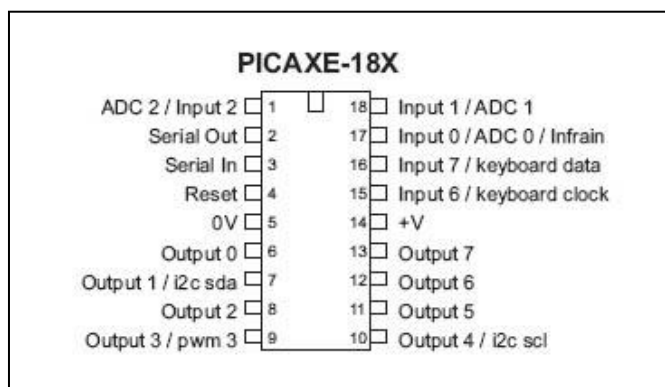



Solutions

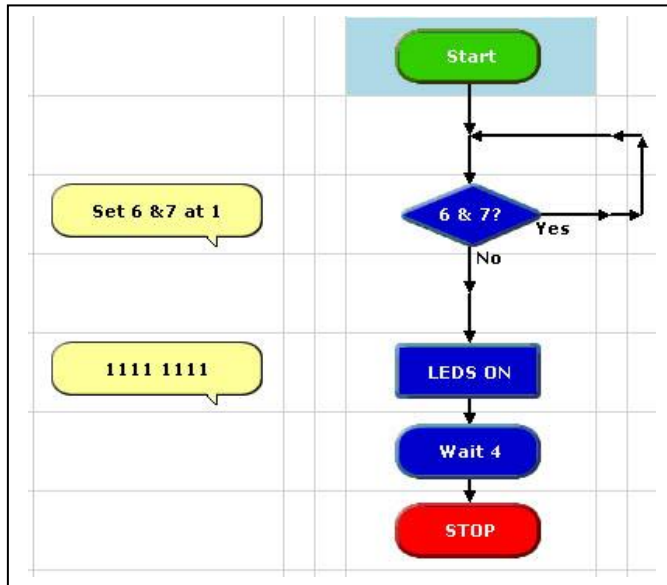

When both switches are pressed the YES route is followed. As long as both switches are pressed the program will continually loop through the decision box. If either one or both of the switches are released then the NO route is followed and the LEDS are switched on.